

# ICC-ES Evaluation Report

**ESR-5046**

Reissued November 2023

This report also contains:

- LABC Supplement

Subject to renewal November 2024

- CBC Supplement

ICC-ES Evaluation Reports are not to be construed as representing aesthetics or any other attributes not specifically addressed, nor are they to be construed as an endorsement of the subject of the report or a recommendation for its use. There is no warranty by ICC Evaluation Service, LLC, express or implied, as to any finding or other matter in this report, or as to any product covered by the report.

Copyright © 2023 ICC Evaluation Service, LLC. All rights reserved.

<p><b>DIVISION: 07 00 00 —</b>  <b>THERMAL AND</b>  <b>MOISTURE</b>  <b>PROTECTION</b></p> <p><b>Section: 07 41 13 —</b>  <b>Metal Roof Panels</b></p>	<p><b>REPORT HOLDER:</b>  <b>TAYLOR METAL, INC.</b>  <b>(dba TAYLOR METAL</b>  <b>PRODUCTS)</b></p>	<p><b>EVALUATION SUBJECT:</b>  <b>TMP METAL ROOFING</b>  <b>PANELS</b></p>	
--	---	--	---

## 1.0 EVALUATION SCOPE

### 1.1 Compliance with the following codes:

- 2021 and 2018 [International Building Code® \(IBC\)](#)
- 2021 and 2018 [International Residential Code® \(IRC\)](#)

For evaluation for compliance with codes adopted by [Los Angeles Department of Building and Safety \(LADBS\)](#), see [ESR-5046 LABC Supplement](#).

For evaluation for compliance with codes adopted by California Office of Statewide Health Planning and Development (OSHPD) AKA: California Department of Health Care Access and Information (HCAI) and the Division of State Architect (DSA), see [ESR-5046 CBC Supplement](#).

### Properties evaluated:

- Weather resistance
- Fire classification
- Structural
- Wind uplift resistance

### 1.2 Evaluation of the following green code:

- 2022 [California Green Building Standards Code \(CALGreen\)](#), Title 24, Part 11

### Attributes verified:

See Section 3.1.

## 2.0 USES

The TMP metal roofing panels are used as roof coverings over solid or closely fitted decking and spaced supports.

## 3.0 DESCRIPTION

### 3.1 General:

The TMP metal roofing panels are cold-formed from steel and/or aluminum conforming to the product specifications, galvalume or zinc coatings, and base-metal thicknesses noted in [Table 1](#). The clips used to

attach the standing seam metal roof panels to the supporting roof structure are made from materials conforming to the product specifications and base metal thicknesses noted in [Table 2](#). See [Figures 1](#) and [2](#) for panel and clip details, respectively.

The attributes of the metal roofing panels have been verified as conforming to the provisions of CALGreen Section A5.406.1.2 for reduced maintenance. Note that decisions on compliance for those areas rest with the user of this report. The user is advised of the project-specific provisions that may be contingent upon meeting specific conditions, and the verification of those conditions is outside the scope of this report. These codes or standards often provide supplemental information as guidance.

### 3.2 Deck Material:

Solid or closely fitted decking must be a minimum of  $1\frac{5}{32}$ -inch-thick (11.9 mm) plywood or lumber sheathing complying with IBC Section 2304.8.2 or IRC Section R803, or minimum No. 22 gauge [0.030 inch thick (0.76 mm)] steel complying with IBC Section 2210.1.1.2.

### 3.3 Underlayment and Flashing:

Underlayment must be in accordance with IBC Section 1507.4.5 or IRC Section R905.10.5, as applicable. Where specified in [Table 6](#), the underlayment is Versashield® Fire-Resistant Roof Deck Protection (ESR-2053) or Polystick XFR (ESR-1697). Flashing must be in accordance with IBC Section 1503.2 or IRC Section R903.2, as applicable.

### 3.4 Impact Resistance:

The MS 200 steel roof panels described in this report meet the requirements of 2021 IBC Section 1504.8 (2018 IBC Section 1504.7) for impact resistance when installed on roofs with a slope less than 2:12 (16.7 percent slope).

## 4.0 DESIGN AND INSTALLATION

### 4.1 Installation:

Installation of the TMP metal roof panels must be in accordance with this report, IBC Section 1507.4, or IRC Section R905.10, and the manufacturer's published installation instructions. The manufacturer's installation instructions must be available at the jobsite at all times during installation.

The panels must be installed on roofs with a minimum slope of 2:12 (16.7-percent slope), except for MS 200 steel roof panels which can be installed in roof slopes greater than  $\frac{1}{4}$ : 12 (2 percent slope). Penetrations and terminations of the panels must be flashed and made weathertight in accordance with the manufacturer's published installation instructions and IBC Section 1503.2 or IRC Section R903.2, as applicable.

### 4.2 Uniform Gravity Loads:

When panels are installed over solid or closely fitted deck sheathing, the capacity is limited to the capacity of the sheathing.

When panels are installed on spaced supports as shown in [Table 5](#), the panels are capable of withstanding the allowable uniform gravity loads and the minimum concentrated live load of 300 lbf (1.33 kN) per IBC Table 1607.1 as indicated in [Table 5](#). The supporting structure must be designed to resist the applicable forces.

### 4.3 Wind Uplift Resistance:

The allowable wind uplift pressures of the panels are provided in [Table 4](#).

### 4.4 Fire Classification:

When installed as specified in [Table 6](#), the metal roof panels are components of roof assemblies classified as Class A or B in accordance with ASTM E108 or UL790.

## 5.0 CONDITIONS OF USE:

The Taylor Metal metal roof panels described in this report comply with, or are suitable alternatives to what is specified in, those codes listed in Section 1.0 of this report, subject to the following conditions:

- 5.1 Installation must comply with the applicable code, this report and the manufacturer's published installation instructions. In the event of conflict between this report and the manufacturer's instructions, this report governs.



- 5.2 The metal panels must be installed only by applicators approved by Taylor Metals, Inc.
- 5.3 Design wind uplift pressure on any roof area, including edge and corner zones, must not exceed the allowable wind pressure for the system installed in that particular area. Refer to the allowable wind uplift pressure for the metal panels as listed in [Table 4](#).
- 5.4 The allowable wind uplift pressures listed in [Table 4](#) are for the roof covering only. The deck and framing to which the roof covering is attached must be designed for the applicable components and cladding wind loads in accordance with the IBC or IRC, as applicable.
- 5.5 Calculations demonstrating that the required wind resistance is less than the allowable wind resistance must be submitted to the code official.
- 5.6 See [Table 1](#) for panel manufacturing location. The manufacturing is under a quality-control program with inspections by ICC-ES.

**6.0 EVIDENCE SUBMITTED**

Data in accordance with the [ICC-ES Acceptance Criteria for Metal Roof Coverings \(AC166\)](#), dated February 2021.

**7.0 IDENTIFICATION**

- 7.1 The panels are identified with a label bearing the product name, the material type, the manufacturer’s name (dba: Taylor Metal Products), and the evaluation report number (ESR-5046).
- 7.2 The report holder’s contact information is the following:

**TAYLOR METAL, INC.**  
 (dba TAYLOR METAL PRODUCTS)  
 4566 RIDGE DRIVE NE  
 SALEM, OREGON 97301  
 (503) 581-8338  
[www.taylormetal.com](http://www.taylormetal.com)

**TABLE 1—MANUFACTURING FACILITIES**

<b>MANUFACTURING FACILITY</b>
TMP-Riverside 4880 Felspar Street Riverside, California 92509

TABLE 2—TAYLOR METAL ROOF PANEL SPECIFICATIONS

PANEL	MATERIAL			MIN. BASE METAL THICKNESS (inch)
	Specification	Classification	Coating	
Versa Span 12"-14"-16"-18" Widths	ASTM A792	SS Grade 50	AZ 50- Painted AZ55-Unpainted	0.0224 (24 gauge) 0.0281 (22 gauge)
	ASTM B209	3003-H14	N/A	0.032
MS-150 12"-16"-18" Widths	ASTM A792	SS Grade 50	AZ 50- Painted AZ55-Unpainted	0.018 (26 gauge) 0.0224 (24 gauge) 0.0281 (22 gauge)
	ASTM B209	3003-H14	N/A	0.032 0.040
MS-200 12"-14"-16"-18" Widths	ASTM A792	SS Grade 50	AZ 50- Painted AZ55-Unpainted	0.0224 (24 gauge) 0.0281 (22 gauge)
	ASTM B209	3003-H14	N/A	0.032 0.040
PBR 36" Width	ASTM A792	SS Grade 50 SS Grade 80 (26 gauge only)	AZ 50- Painted AZ55-Unpainted	0.018 (26 gauge) 0.0224 (24 gauge) 0.0281 (22 gauge)
	ASTM B209	3003-H14	N/A	0.032
HR-34 34" Width	ASTM A792	SS Grade 50 SS Grade 80 (26 gauge only) SS Grade 33 (20 gauge only)	AZ 50- Painted AZ55-Unpainted	0.018 (26 gauge) 0.0224 (24 gauge) 0.0281 (22 gauge) 0.0341 (20 gauge)
	ASTM B209	3003-H14	N/A	0.032 0.040
Classic 7/8 Corrugated 37.33" Width	ASTM A792	SS Grade 50 SS Grade 80 (26 gauge only)	AZ 50- Painted AZ55-Unpainted	0.018 (26 gauge) 0.0224 (24 gauge) 0.0281 (22 gauge)
	ASTM B209	3003-H14	N/A	0.032
BR-36 36" Width	ASTM A792	SS Grade 50 SS Grade 33 (20 gauge only)	AZ 50- Painted AZ55-Unpainted	0.0224 (24 gauge) 0.0281 (22 gauge) 0.0341 (20 gauge)
	ASTM B209	3003-H14	N/A	0.032 0.040

For SI: 1 inch = 25.4 mm.

TABLE 3—TAYLOR METAL ROOF PANEL CLIP SPECIFICATIONS

CLIP	MATERIAL			MIN. BASE STEEL THICKNESS (inch)
	Specification	Classification	Coating	
Versa Span Snap Lock Manufactured by SFS, Clip Master, and AMSI	Galvanized Steel	18 ga. steel ASTM A653 Grade 50	G90	0.046
MS150 Fixed Clip Manufactured by SFS, Clip Master, and AMSI MS 150 Floating Clip Manufactured by SFS, Clip Master, and AMSI	Galvanized Steel	22 ga. steel (fixed) 18/22 ga. (floating) ASTM A653 Grade 50	G90	0.046 (BASE)- 0.028 (FIXED AND TOP)
MS200 Fixed Clip Manufactured by SFS, Clip Master, and AMSI	Galvanized Steel	22 ga. steel ASTM A653 Grade 50	G90	0.028
2" Float Engineered Panel Floating Clip Manufactured by SFS	Galvanized Steel	16 ga. Base/22 ga. Top- steel ASTM A653 Grade 50	G90	0.0575 (BASE)- 0.028 (TOP)

For SI: 1 inch = 25.4 mm.

TABLE 4—ALLOWABLE WIND UPLIFT PRESSURES

TAYLOR METAL ROOF PANEL	SUPPORT	FASTENING PATTERN <sup>1</sup>	PANEL SPAN <sup>2</sup> (inch)	ALLOWABLE UPLIFT PRESSURE (psf)
16" wide Versa Span (0.032" Aluminum)	Min. 30 mil steel deck -or- Min. 15/32-inch-thick plywood -or- Min. 56 mil steel purlins (open framing)	Versa Span Snap Lock fastened to supporting structure with two (2) No. 10 phillip pancake self-drilling screws	12	46.8
			18	42.4
			24	38.1
			30	33.8
			36	29.4
			42	25.1
18" wide Versa Span (0.032" Aluminum)	Min. 30 mil steel deck -or- Min. 15/32-inch-thick plywood -or- Min. 56 mil steel purlins (open framing)	Versa Span Snap Lock fastened to supporting structure with two (2) No. 10 phillip pancake self-drilling screws	48	20.8
			12	54.6
			18	48.5
			24	42.4
			30	36.4
			36	30.3
16" wide Versa Span (24 ga. steel)	Min. 30 mil steel deck -or- Min. 15/32-inch-thick plywood -or- Min. 56 mil steel purlins (open framing)	Versa Span Snap Lock fastened to supporting structure with two (2) No. 10 phillip pancake self-drilling screws	42	24.2
			48	18.2
			12	83.2
			18	73.6
			24	64.1
			30	54.6
16" wide Versa Span (22 ga. steel)	Min. 30 mil steel deck -or- Min. 15/32-inch-thick plywood -or- Min. 56 mil steel purlins (open framing)	Versa Span Snap Lock fastened to supporting structure with two (2) No. 10 phillip pancake self-drilling screws	36	45.0
			42	35.5
			48	26.0
			12	93.6
			18	87.1
			24	78.0
18" wide Versa Span (24 ga. steel)	Min. 30 mil steel deck -or- Min. 15/32-inch-thick plywood -or- Min. 56 mil steel purlins (open framing)	Versa Span Snap Lock fastened to supporting structure with two (2) No. 10 phillip pancake self-drilling screws	30	68.9
			36	59.8
			42	50.7
			48	41.6
			12	67.6
			18	59.8
18" wide Versa Span (22 ga. steel)	Min. 30 mil steel deck -or- Min. 15/32-inch-thick plywood -or- Min. 56 mil steel purlins (open framing)	Versa Span Snap Lock fastened to supporting structure with two (2) No. 10 phillip pancake self-drilling screws	24	52.0
			30	44.2
			36	36.4
			42	28.6
			48	20.8
			12	90.1
18" wide Versa Span (22 ga. steel)	Min. 30 mil steel deck -or- Min. 15/32-inch-thick plywood -or- Min. 56 mil steel purlins (open framing)	Versa Span Snap Lock fastened to supporting structure with two (2) No. 10 phillip pancake self-drilling screws	18	79.8
			24	69.6
			30	59.3
			36	49.1
			42	38.8
			48	28.6



TABLE 4—ALLOWABLE WIND UPLIFT PRESSURES (continued)

TAYLOR METAL ROOF PANEL	SUPPORT	FASTENING PATTERN <sup>1</sup>	PANEL SPAN <sup>2</sup> (inch)	ALLOWABLE UPLIFT PRESSURE (psf)
16.75" wide MS150-90 degree seam (0.032" and 0.040" aluminum)	Min. 30 mil steel deck -or- Min. 15/32-inch-thick plywood -or- Min. 56 mil steel purlins (open framing)	TMP MS 150 Clip fastened to supporting structure with two (2) No. 10 pancake head self-drilling screws	12	36.4
			18	32.5
			24	28.6
			30	24.7
			36	20.8
			42	16.9
			48	13.0
16.75" wide MS150-90 degree seam (24 ga. steel)	Min. 30 mil steel deck -or- Min. 15/32-inch-thick plywood -or- Min. 56 mil steel purlins (open framing)	TMP MS 150 Clip fastened to supporting structure with two (2) No. 10 pancake head self-drilling screws	12	13.0
			18	12.1
			24	11.3
			30	10.4
			36	9.5
			42	8.7
			48	7.8
16.75" wide MS150-90 degree seam (22 ga. steel)	Min. 30 mil steel deck -or- Min. 15/32-inch-thick plywood -or- Min. 56 mil steel purlins (open framing)	TMP MS 150 Clip fastened to supporting structure with two (2) No. 10 pancake head self-drilling screws	12	57.3
			18	50.4
			24	43.4
			30	36.5
			36	29.5
			42	22.6
			48	15.6
12.625" wide MS150-180 degree seam (0.032" and 0.040" aluminum)	Min. 30 mil steel deck -or- Min. 15/32-inch-thick plywood -or- Min. 56 mil steel purlins (open framing)	TMP MS 150 Clip fastened to supporting structure with two (2) No. 10 pancake head self-drilling screws	12	111.9
			18	100.1
			24	88.4
			30	76.7
			36	65.0
			42	53.3
			48	41.6
12.625" wide MS150-180 degree/double lock seam (24 ga. steel)	Min. 30 mil steel deck -or- Min. 15/32-inch-thick plywood -or- Min. 56 mil steel purlins (open framing)	TMP MS 150 Clip fastened to supporting structure with two (2) No. 10 pancake head self-drilling screws	12	137.9
			18	124.0
			24	110.2
			30	96.3
			36	82.4
			42	68.6
			48	54.7
12" wide MS150-180 degree/double lock seam (22 ga. steel)	Min. 30 mil steel deck -or- Min. 15/32-inch-thick plywood -or- Min. 56 mil steel purlins (open framing)	TMP MS 150 Clip fastened to supporting structure with two (2) No. 10 pancake head self-drilling screws	12	182.2
			18	161.8
			24	141.4
			30	121.1
			36	100.7
			42	80.3
			48	59.9
16.625" wide MS150-180 degree/double lock seam (24 ga. steel)	Min. 30 mil steel deck -or- Min. 15/32-inch-thick plywood -or- Min. 56 mil steel purlins (open framing)	TMP MS 150 Clip fastened to supporting structure with two (2) No. 10 pancake head self-drilling screws	12	119.7
			18	107.1
			24	94.5
			30	81.9
			36	69.4
			42	56.8
			48	44.2
16.625" wide MS150-180 degree/double lock seam (22 ga. steel)	Min. 30 mil steel deck -or- Min. 15/32-inch-thick plywood -or- Min. 56 mil steel purlins (open framing)	TMP MS 150 Clip fastened to supporting structure with two (2) No. 10 pancake head self-drilling screws	12	145.7
			18	128.8
			24	111.9
			30	95.0
			36	78.0
			42	61.1
			48	44.2
18" wide MS150-180 degree/double lock seam (0.032" and 0.040" aluminum)	Min. 30 mil steel deck -or- Min. 15/32-inch-thick plywood -or- Min. 56 mil steel purlins (open framing)	TMP MS 150 Clip fastened to supporting structure with two (2) No. 10 pancake head self-drilling screws	12	83.3
			18	73.7
			24	64.2
			30	54.6
			36	45.1
			42	35.5
			48	26.0
18" wide MS150-180 degree/double lock seam (24 ga. steel)	Min. 30 mil steel deck -or- Min. 15/32-inch-thick plywood -or- Min. 56 mil steel purlins (open framing)	TMP MS 150 Clip fastened to supporting structure with two (2) No. 10 pancake head self-drilling screws	12	109.3
			18	97.1
			24	85.0
			30	72.8
			36	60.7
			42	48.5
			48	36.4

TABLE 4—ALLOWABLE WIND UPLIFT PRESSURES (continued)

TAYLOR METAL ROOF PANEL	SUPPORT	FASTENING PATTERN <sup>1</sup>	PANEL SPAN <sup>2</sup> (inch)	ALLOWABLE UPLIFT PRESSURE (psf)
18" wide MS150-180 degree/double lock seam (22 ga. steel)	Min. 30 mil steel deck -or- Min. 15/32-inch-thick plywood -or- Min. 56 mil steel purlins (open framing)	TMP MS 150 Clip fastened to supporting structure with two (2) No. 10 pancake head self-drilling screws	12	124.9
			18	111.5
			24	98.0
			30	84.6
			36	71.1
			42	57.7
			48	44.2
18" wide MS200-90 degree/single lock seam (0.032" aluminum)	Min. 30 mil steel deck -or- Min. 15/32-inch-thick plywood -or- Min. 56 mil steel purlins (open framing)	TMP MS 200 Clip fastened to supporting structure with two (2) No. 10 pancake head self-drilling screw	12	36.4
			18	32.5
			24	28.6
			30	24.7
			36	20.8
			42	16.9
			48	13.0
18" wide MS200-90 degree/single lock seam (0.040" aluminum)	Min. 30 mil steel deck -or- Min. 15/32-inch-thick plywood -or- Min. 56 mil steel purlins (open framing)	TMP MS 200 Clip fastened to supporting structure with two (2) No. 10 pancake head self-drilling screw	12	46.9
			18	42.6
			24	38.2
			30	33.4
			36	29.5
			42	25.2
			48	20.8
18" wide MS200-90 degree/single lock seam (24 ga. steel)	Min. 30 mil steel deck -or- Min. 15/32-inch-thick plywood -or- Min. 56 mil steel purlins (open framing)	TMP MS 200 Clip fastened to supporting structure with two (2) No. 10 pancake head self-drilling screw	12	59.9
			18	53.4
			24	46.9
			30	40.4
			36	33.8
			42	27.3
			48	20.8
18" wide MS200-90 degree/single lock seam single lock seam (22 ga. steel)	Min. 30 mil steel deck -or- Min. 15/32-inch-thick plywood -or- Min. 56 mil steel purlins (open framing)	TMP MS 200 Clip fastened to supporting structure with two (2) No. 10 pancake head self-drilling screw	12	98.9
			18	88.1
			24	77.2
			30	66.4
			36	55.5
			42	44.7
			48	33.8
16" wide MS200-180 degree/double lock seam (24 ga. steel)	Min. 30 mil steel deck -or- Min. 15/32-inch-thick plywood -or- Min. 56 mil steel purlins (open framing)	2" float engineered panel clip connected to supporting structure with two (2) No. 14 screws	12	161.3
			18	147.6
			24	134.0
			30	120.3
			36	106.7
			42	93.0
			48	79.4
54	67.7			
60	52.1			
16" wide MS200-180 degree/double lock seam (22 ga. steel)	Min. 30 mil steel deck -or- Min. 15/32-inch-thick plywood -or- Min. 56 mil steel purlins (open framing)	2" float engineered panel clip connected to supporting structure with two (2) No. 14 screws	12	163.9
			18	150.9
			24	137.9
			30	124.9
			36	111.9
			42	98.9
			48	85.9
54	72.9			
60	59.9			
18" wide MS200-180 degree/double lock seam (0.032" aluminum)	Min. 30 mil steel deck -or- Min. 15/32-inch-thick plywood -or- Min. 56 mil steel purlins (open framing)	2" float engineered panel clip connected to supporting structure with two (2) No. 14 screws	12	83.3
			18	77.4
			24	71.5
			30	65.7
			36	59.8
			42	54.0
			48	48.1
54	42.3			
60	36.4			
18" wide MS200-180 degree/double lock seam (24 ga. steel)	Min. 30 mil steel deck -or- Min. 15/32-inch-thick plywood -or- Min. 56 mil steel purlins (open framing)	2" float engineered panel clip connected to supporting structure with two (2) No. 14 screws	12	109.3
			18	101.1
			24	93.0
			30	84.9
			36	76.7
			42	68.6
			48	60.5
54	52.3			
60	44.2			



TABLE 4—ALLOWABLE WIND UPLIFT PRESSURES (continued)

TAYLOR METAL ROOF PANEL	SUPPORT	FASTENING PATTERN <sup>1</sup>	PANEL SPAN <sup>2</sup> (inch)	ALLOWABLE UPLIFT PRESSURE (psf)
18" wide MS200-180 degree/double lock seam (22 ga. steel)	Min. 30 mil steel deck -or- Min. 15/32-inch-thick plywood -or- Min. 56 mil steel purlins (open framing)	2" float engineered panel clip connected to supporting structure with two (2) No. 14 screws	12	156.1
			18	143.4
			24	130.7
			30	118.0
			36	105.4
			42	92.7
			48	80.0
			54	67.3
36" wide PBR (0.032" aluminum)	Min. 30 mil steel deck -or- Min. 15/32-inch-thick plywood -or- Min. 56 mil steel purlins (open framing)	Minimum six (6) No. 14 hex-head self-drilling screws across the panel width at all supports  Sidelap fasteners are No. 14 hex-head self-drilling screws at 12" o.c.	24	187.5
			30	165.5
			36	143.3
			42	121.3
			48	99.2
			54	77.1
			60	55.0
			36" wide PBR (26 ga. steel)	Min. 30 mil steel deck -or- Min. 15/32-inch-thick plywood -or- Min. 56 mil steel purlins (open framing)
30	92.5			
36	85.0			
42	77.5			
48	70.0			
54	62.5			
60	55.0			
36" wide PBR (24 ga. steel)	Min. 30 mil steel deck -or- Min. 15/32-inch-thick plywood -or- Min. 56 mil steel purlins (open framing)	Minimum six (6) No. 14 hex-head self-drilling screws across the panel width at all supports  Sidelap fasteners are No. 14 hex-head self-drilling screws at 12" o.c.		
			30	156.7
			36	138.3
			42	120.0
			48	101.7
			54	83.3
			60	65.0
			36" wide PBR (22 ga. steel)	Min. 30 mil steel deck -or- Min. 15/32-inch-thick plywood -or- Min. 56 mil steel purlins (open framing)
30	178.3			
36	156.7			
42	135.0			
48	113.3			
54	91.7			
60	70.0			
34" wide HR-34 (0.032" aluminum)	Min. 30 mil steel deck -or- Min. 15/32-inch-thick plywood -or- Min. 56 mil steel purlins (open framing)	Minimum three (3) No. 12 hex-head self-drilling screws across the panel width at all supports  Sidelap fasteners are No. 12 hex-head self-drilling screws at 12" o.c.		
			30	100.8
			36	89.7
			42	78.5
			48	67.3
			54	56.2
			60	45.0
			34" wide HR-34 (0.040" aluminum)	Min. 30 mil steel deck -or- Min. 15/32-inch-thick plywood -or- Min. 56 mil steel purlins (open framing)
30	90.0			
36	80.0			
42	70.0			
48	60.0			
54	50.0			
60	40.0			
34" wide HR-34 (26 ga. steel)	Min. 30 mil steel deck -or- Min. 15/32-inch-thick plywood -or- Min. 56 mil steel purlins (open framing)	Minimum three (3) No. 12 hex-head self-drilling screws across the panel width at all supports  Sidelap fasteners are No. 12 hex-head self-drilling screws at 12" o.c.		
			30	80.4
			36	73.3
			42	66.3
			48	59.2
			54	52.1
			60	45.0
			34" wide HR-34 (24 ga. steel)	Min. 30 mil steel deck -or- Min. 15/32-inch-thick plywood -or- Min. 56 mil steel purlins (open framing)
30	90.8			
36	81.7			
42	72.5			
48	63.3			
54	54.2			
60	45.0			
34" wide HR-34 (22 ga. steel)	Min. 30 mil steel deck -or- Min. 15/32-inch-thick plywood -or- Min. 56 mil steel purlins (open framing)	Minimum three (3) No. 12 hex-head self-drilling screws across the panel width at all supports  Sidelap fasteners are No. 12 hex-head self-drilling screws at 12" o.c.		
			30	90.8
			36	81.7
			42	72.5
			48	63.3
			54	54.2
			60	45.0



TABLE 4—ALLOWABLE WIND UPLIFT PRESSURES (continued)

TAYLOR METAL ROOF PANEL	SUPPORT	FASTENING PATTERN <sup>1</sup>	PANEL SPAN <sup>2</sup> (inch)	ALLOWABLE UPLIFT PRESSURE (psf)
34" wide HR-34 (20 ga. steel)	Min. 30 mil steel deck -or- Min. 15/32-inch-thick plywood -or- Min. 56 mil steel purlins (open framing)	Minimum three (3) No. 12 hex-head self-drilling screws across the panel width at all supports  Sidelap fasteners are No. 12 hex-head self-drilling screws at 12" o.c.	24	105.0
			30	95.8
			36	86.7
			42	77.5
			48	68.3
			54	59.2
			60	50.0
34" wide HR-34 (0.032" aluminum)	Min. 30 mil steel deck -or- Min. 15/32-inch-thick plywood -or- Min. 56 mil steel purlins (open framing)	Minimum five (5) No. 12 hex-head self-drilling screws across the panel width at all supports  Sidelap fasteners are No. 12 hex-head self-drilling screws at 12" o.c.	24	120.0
			30	108.3
			36	96.7
			42	85.0
			48	73.3
			54	61.7
			60	50.0
34" wide HR-34 (0.040" aluminum)	Min. 30 mil steel deck -or- Min. 15/32-inch-thick plywood -or- Min. 56 mil steel purlins (open framing)	Minimum five (5) No. 12 hex-head self-drilling screws across the panel width at all supports  Sidelap fasteners are No. 12 hex-head self-drilling screws at 12" o.c.	24	200.0
			30	177.1
			36	154.2
			42	131.1
			48	108.3
			54	85.4
			60	62.5
34" wide HR-34 (26 ga. steel)	Min. 30 mil steel deck -or- Min. 15/32-inch-thick plywood -or- Min. 56 mil steel purlins (open framing)	Minimum five (5) No. 12 hex-head self-drilling screws across the panel width at all supports  Sidelap fasteners are No. 12 hex-head self-drilling screws at 12" o.c.	24	175.0
			30	157.5
			36	140.0
			42	122.5
			48	105.0
			54	87.5
			60	70.0
34" wide HR-34 (24 ga. steel)	Min. 30 mil steel deck -or- Min. 15/32-inch-thick plywood -or- Min. 56 mil steel purlins (open framing)	Minimum five (5) No. 12 hex-head self-drilling screws across the panel width at all supports  Sidelap fasteners are No. 12 hex-head self-drilling screws at 12" o.c.	24	200.0
			30	180.0
			36	160.0
			42	140.0
			48	120.0
			54	100.0
			60	80.0
34" wide HR-34 (22 ga. steel)	Min. 30 mil steel deck -or- Min. 15/32-inch-thick plywood -or- Min. 56 mil steel purlins (open framing)	Minimum five (5) No. 12 hex-head self-drilling screws across the panel width at all supports  Sidelap fasteners are No. 12 hex-head self-drilling screws at 12" o.c.	24	200.0
			30	178.3
			36	156.7
			42	135.0
			48	113.3
			54	91.7
			60	70.0
34" wide HR-34 (20 ga. steel)	Min. 30 mil steel deck -or- Min. 15/32-inch-thick plywood -or- Min. 56 mil steel purlins (open framing)	Minimum five (5) No. 12 hex-head self-drilling screws across the panel width at all supports  Sidelap fasteners are No. 12 hex-head self-drilling screws at 12" o.c.	24	200.0
			30	179.2
			36	158.3
			42	137.5
			48	116.7
			54	95.8
			60	75.0
37.33" wide Classic 7/8 Corrugated (0.032" aluminum)	Min. 30 mil steel deck -or- Min. 15/32-inch-thick plywood -or- Min. 56 mil steel purlins (open framing)	Minimum five (5) No. 12 hex-head self-drilling screws across the panel width at all supports  Sidelap fasteners are No. 12 hex-head self-drilling screws at 12" o.c.	24	55.0
			30	50.8
			36	46.7
			42	42.5
			48	38.3
			54	34.2
			60	30.0
37.33" wide Classic 7/8 Corrugated (26 ga. steel)	Min. 30 mil steel deck -or- Min. 15/32-inch-thick plywood -or- Min. 56 mil steel purlins (open framing)	Minimum five (5) No. 12 hex-head self-drilling screws across the panel width at all supports  Sidelap fasteners are No. 12 hex-head self-drilling screws at 12" o.c.	24	110.0
			30	100.4
			36	90.8
			42	81.3
			48	71.7
			54	62.1
			60	52.5
37.33" wide Classic 7/8 Corrugated (24 ga. steel)	Min. 30 mil steel deck -or- Min. 15/32-inch-thick plywood -or- Min. 56 mil steel purlins (open framing)	Minimum five (5) No. 12 hex-head self-drilling screws across the panel width at all supports  Sidelap fasteners are No. 12 hex-head self-drilling screws at 12" o.c.	24	117.5
			30	108.3
			36	99.2
			42	90.0
			48	80.8
			54	71.7
			60	62.5

TABLE 4—ALLOWABLE WIND UPLIFT PRESSURES (continued)

TAYLOR METAL ROOF PANEL	SUPPORT	FASTENING PATTERN <sup>1</sup>	PANEL SPAN <sup>2</sup> (inch)	ALLOWABLE UPLIFT PRESSURE (psf)
37.33" wide Classic 7/8 Corrugated (22 ga. steel)	Min. 30 mil steel deck -or- Min. 15/32-inch-thick plywood -or- Min. 56 mil steel purlins (open framing)	Minimum five (5) No. 12 hex-head self-drilling screws across the panel width at all supports  Sidelap fasteners are No. 12 hex-head self-drilling screws at 12" o.c.	24	150.0
			30	135.4
			36	120.8
			42	106.3
			48	91.7
			54	77.1
			60	62.5
37.33" wide Classic 7/8 Corrugated (0.032" aluminum)	Min. 30 mil steel deck -or- Min. 15/32-inch-thick plywood -or- Min. 56 mil steel purlins (open framing)	Minimum seven (7) No. 12 hex-head self-drilling screws across the panel width at all supports  Sidelap fasteners are No. 12 hex-head self-drilling screws at 12" o.c.	24	175.0
			30	155.0
			36	135.0
			42	115.0
			48	95.0
			54	75.0
			60	55.0
37.33" wide Classic 7/8 Corrugated (26 ga. steel)	Min. 30 mil steel deck -or- Min. 15/32-inch-thick plywood -or- Min. 56 mil steel purlins (open framing)	Minimum seven (7) No. 12 hex-head self-drilling screws across the panel width at all supports  Sidelap fasteners are No. 12 hex-head self-drilling screws at 12" o.c.	24	162.5
			30	162.5
			36	162.5
			42	162.5
			48	162.5
			54	162.5
			60	162.5
37.33" wide Classic 7/8 Corrugated (24 ga. steel)	Min. 30 mil steel deck -or- Min. 15/32-inch-thick plywood -or- Min. 56 mil steel purlins (open framing)	Minimum seven (7) No. 12 hex-head self-drilling screws across the panel width at all supports  Sidelap fasteners are No. 12 hex-head self-drilling screws at 12" o.c.	24	162.5
			30	108.3
			36	99.2
			42	90.0
			48	80.8
			54	71.7
			60	75.0
37.33" wide Classic 7/8 Corrugated (22 ga. steel)	Min. 30 mil steel deck -or- Min. 15/32-inch-thick plywood -or- Min. 56 mil steel purlins (open framing)	Minimum seven (7) No. 12 hex-head self-drilling screws across the panel width at all supports  Sidelap fasteners are No. 12 hex-head self-drilling screws at 12" o.c.	24	175.0
			30	135.4
			36	120.8
			42	106.3
			48	91.7
			54	77.1
			60	75.0
36" wide BR-36 (0.032" aluminum)	Min. 30 mil steel deck -or- Min. 15/32-inch-thick plywood -or- Min. 56 mil steel purlins (open framing)	Minimum three (3) No. 12 hex-head self-drilling screws across the panel width at all supports  Sidelap fasteners are No. 12 hex-head self-drilling screws at 12" o.c.	24	55.0
			30	51.7
			36	48.3
			42	45.0
			48	41.7
			54	38.3
			60	35.0
36" wide BR-36 (0.040" aluminum)	Min. 30 mil steel deck -or- Min. 15/32-inch-thick plywood -or- Min. 56 mil steel purlins (open framing)	Minimum three (3) No. 12 hex-head self-drilling screws across the panel width at all supports  Sidelap fasteners are No. 12 hex-head self-drilling screws at 12" o.c.	24	75.0
			30	69.2
			36	63.3
			42	57.5
			48	51.7
			54	45.8
			60	40.0
36" wide BR-36 (24 ga. steel)	Min. 30 mil steel deck -or- Min. 15/32-inch-thick plywood -or- Min. 56 mil steel purlins (open framing)	Minimum three (3) No. 12 hex-head self-drilling screws across the panel width at all supports  Sidelap fasteners are No. 12 hex-head self-drilling screws at 12" o.c.	24	137.5
			30	122.1
			36	106.7
			42	91.3
			48	75.8
			54	60.4
			60	45.0
36" wide BR-36 (22 ga. steel)	Min. 30 mil steel deck -or- Min. 15/32-inch-thick plywood -or- Min. 56 mil steel purlins (open framing)	Minimum three (3) No. 12 hex-head self-drilling screws across the panel width at all supports  Sidelap fasteners are No. 12 hex-head self-drilling screws at 12" o.c.	24	100.0
			30	90.0
			36	80.0
			42	70.0
			48	60.0
			54	50.0
			60	40.0
36" wide BR-36 (20 ga. steel)	Min. 30 mil steel deck -or- Min. 15/32-inch-thick plywood -or- Min. 56 mil steel purlins (open framing)	Minimum three (3) No. 12 hex-head self-drilling screws across the panel width at all supports  Sidelap fasteners are No. 12 hex-head self-drilling screws at 12" o.c.	24	100.0
			30	89.8
			36	79.7
			42	69.5
			48	59.3
			54	49.2
			60	39.0



TABLE 4—ALLOWABLE WIND UPLIFT PRESSURES (continued)

TAYLOR METAL ROOF PANEL	SUPPORT	FASTENING PATTERN <sup>1</sup>	PANEL SPAN <sup>2</sup> (inch)	ALLOWABLE UPLIFT PRESSURE (psf)
36" wide BR-36 (0.032" aluminum)	Min. 30 mil steel deck -or- Min. 15/32-inch-thick plywood -or- Min. 56 mil steel purlins (open framing)	Minimum five (5) No. 12 hex-head self-drilling screws across the panel width at all supports  Sidelap fasteners are No. 12 hex-head self-drilling screws at 12" o.c.	24	135.0
			30	122.7
			36	110.3
			42	98.0
			48	85.7
			54	73.3
36" wide BR-36 (0.040" aluminum)	Min. 30 mil steel deck -or- Min. 15/32-inch-thick plywood -or- Min. 56 mil steel purlins (open framing)	Minimum five (5) No. 12 hex-head self-drilling screws across the panel width at all supports  Sidelap fasteners are No. 12 hex-head self-drilling screws at 12" o.c.	60	61.0
			24	171.0
			30	150.8
			36	130.7
			42	110.5
			48	90.3
36" wide BR-36 (24 ga. steel)	Min. 30 mil steel deck -or- Min. 15/32-inch-thick plywood -or- Min. 56 mil steel purlins (open framing)	Minimum five (5) No. 12 hex-head self-drilling screws across the panel width at all supports  Sidelap fasteners are No. 12 hex-head self-drilling screws at 12" o.c.	54	70.2
			60	50.0
			24	200.0
			30	179.2
			36	158.3
			42	137.5
36" wide BR-36 (22 ga. steel)	Min. 30 mil steel deck -or- Min. 15/32-inch-thick plywood -or- Min. 56 mil steel purlins (open framing)	Minimum five (5) No. 12 hex-head self-drilling screws across the panel width at all supports  Sidelap fasteners are No. 12 hex-head self-drilling screws at 12" o.c.	48	116.7
			54	95.8
			60	75.0
			24	200.0
			30	180.0
			36	160.0
36" wide BR-36 (20 ga. steel)	Min. 30 mil steel deck -or- Min. 15/32-inch-thick plywood -or- Min. 56 mil steel purlins (open framing)	Minimum five (5) No. 12 hex-head self-drilling screws across the panel width at all supports  Sidelap fasteners are No. 12 hex-head self-drilling screws at 12" o.c.	42	140.0
			48	120.0
			54	100.0
			60	80.0
			24	170
			30	153.1
36" wide BR-36 (20 ga. steel)	Min. 30 mil steel deck -or- Min. 15/32-inch-thick plywood -or- Min. 56 mil steel purlins (open framing)	Minimum five (5) No. 12 hex-head self-drilling screws across the panel width at all supports  Sidelap fasteners are No. 12 hex-head self-drilling screws at 12" o.c.	36	136.2
			42	119.3
			48	102.3
			54	85.4
			60	68.5

For SI: 1 inch = 25.4 mm, 1 psf = 0.0479 kPa.

<sup>1</sup>Tabulated values do not consider panel clip connection to supporting structure, which must be determined by registered design professional. Tabulated values do not consider pry effect applied to the fastener by the clip base, which must be performed by registered design professional.

<sup>2</sup>The panel span for the Versa Span, MS150 and MS200 standing seam metal roof panels represent the maximum clip spacing along the seam. The panel span for the PBR, HR-34, Classic Corrugated 7/8 and BR-36 metal roof panels represent the maximum support member spacing.

TABLE 5- ALLOWABLE UNIFORM GRAVITY LOADS FOR METAL ROOF PANELS INSTALLED ON SPACED SUPPORTS<sup>1,2</sup>

TAYLOR METAL ROOF PANEL	SUPPORT	FASTENING PATTERN	MAXIMUM SUPPORT SPACING (inches)	ALLOWABLE UNIFORM LOAD (psf)
16" wide Versa Span (0.032" Aluminum)	Min 2.5-inch wide support <sup>3</sup>	See <a href="#">Table 4</a>	24	37.7
			30	30.2
			36	25.2
18" wide Versa Span (0.032" Aluminum)	Min 2.5-inch wide support <sup>3</sup>	See <a href="#">Table 4</a>	24	33.6
			30	26.9
			36	22.4
16" wide Versa Span (24 ga. steel)	Min 2.5-inch wide support <sup>3</sup>	See <a href="#">Table 4</a>	24	208.6
			30	166.9
			36	133.3
			42	98.0
			48	75.0
			54	59.3
16" wide Versa Span (22 ga. steel)	Min 2.5-inch wide support <sup>3</sup>	See <a href="#">Table 4</a>	60	48.0
			24	440.0
			30	330.8
			36	229.7
			42	168.8
			48	129.2
			54	102.1
			60	82.7
			66	68.4
72	57.4			

**TABLE 5- ALLOWABLE UNIFORM GRAVITY LOADS FOR METAL ROOF PANELS INSTALLED ON SPACED SUPPORTS<sup>1,2</sup>**  
(continued)

TAYLOR METAL ROOF PANEL	SUPPORT	FASTENING PATTERN	MAXIMUM SUPPORT SPACING (inches)	ALLOWABLE UNIFORM LOAD (psf)
18" wide Versa Span (24 ga. Steel)	Min 2.5-inch wide support <sup>3</sup>	See <a href="#">Table 4</a>	24	185.5
			30	148.4
			36	118.3
			42	86.9
			48	66.6
			54	52.6
16" wide MS150 (0.032" aluminum) single and double lock	Min 2.5-inch wide support <sup>3</sup>	See <a href="#">Table 4</a>	24	22.4
			30	22.2
16" wide MS150 (24 ga. Steel) single and double lock	Min 2.5-inch wide support <sup>3</sup>	See <a href="#">Table 4</a>	24	209.6
			30	167.6
			36	139.7
			42	119.7
			48	104.8
			54	93.1
			60	77.7
			66	64.2
			72	54.0
			16" wide MS150 (22 ga. Steel) single and double lock	Min 2.5-inch wide support <sup>3</sup>
30	242.6			
36	202.1			
42	173.3			
48	147.0			
54	116.2			
60	94.1			
66	77.8			
72	65.4			
12" wide MS150 (0.032" aluminum) single and double lock	Min 2.5-inch wide support <sup>3</sup>	See <a href="#">Table 4</a>		
			30	25.5
12" wide MS150 (24 ga. Steel) single and double lock	Min 2.5-inch wide support <sup>3</sup>	See <a href="#">Table 4</a>	24	279.6
			30	223.6
			36	186.4
			42	159.7
			48	138.8
			54	124.2
			60	106.8
			66	88.3
			72	74.2
			12" wide MS150 (22 ga. Steel) single and double lock	Min 2.5-inch wide support <sup>3</sup>
30	323.6			
36	269.7			
42	225.3			
48	172.5			
54	136.3			
60	110.4			
66	91.2			
18" wide MS150 (24 ga. Steel) single and double lock	Min 2.5-inch wide support <sup>3</sup>	See <a href="#">Table 4</a>	24	125.5
			30	100.4
			36	83.6
			42	71.7
			48	62.7
			54	55.8
			60	50.2
18" wide MS150 (22 ga. Steel) single and double lock	Min 2.5-inch wide support <sup>3</sup>	See <a href="#">Table 4</a>	24	269.6
			30	215.6
			36	179.7
			42	154.0
			48	131.1
			54	103.6
			60	83.9
			66	69.3
72	58.3			



**TABLE 5- ALLOWABLE UNIFORM GRAVITY LOADS FOR METAL ROOF PANELS INSTALLED ON SPACED SUPPORTS<sup>1,2</sup>**  
(continued)

TAYLOR METAL ROOF PANEL	SUPPORT	FASTENING PATTERN	MAXIMUM SUPPORT SPACING (inches)	ALLOWABLE UNIFORM LOAD (psf)
18" wide MS200 (0.032" aluminum) single and double lock	Min 2.5-inch wide support <sup>3</sup>	See <a href="#">Table 4</a>	24	26.2
			30	40.8
18" wide MS200 (0.040" aluminum) single and double lock	Min 2.5-inch wide support <sup>3</sup>	See <a href="#">Table 4</a>	24	26.1
			30	184.1
			36	147.3
			42	122.7
			48	105.2
			54	92.1
			60	81.8
			66	73.6
			72	66.9
			18" wide MS200 (24 ga. steel) single and double lock	Min 2.5-inch wide support <sup>3</sup>
24	266.8			
30	213.5			
36	177.9			
42	152.5			
48	133.4			
54	118.6			
60	106.7			
18" wide MS200 (22 ga. steel) single and double lock	Min 2.5-inch wide support <sup>3</sup>	See <a href="#">Table 4</a>	66	89.3
			72	75.0
			24	207.3
			30	165.8
			36	138.2
			42	118.4
			48	103.6
			54	92.1
16" wide MS200 (24 ga. steel) single and double lock	Min 2.5-inch wide support <sup>3</sup>	See <a href="#">Table 4</a>	60	82.9
			66	75.4
			72	69.1
			24	300.5
			30	240.4
			36	200.3
			42	171.7
			48	150.2
16" wide MS200 (22 ga. steel) single and double lock	Min 2.5-inch wide support <sup>3</sup>	See <a href="#">Table 4</a>	54	133.5
			60	120.2
			66	100.8
			72	84.7
			96	47.7
			24	40.4
			30	32.3
			36	26.9
36" wide PBR (0.032" aluminum)	Min 2.5-inch wide support <sup>3</sup>	See <a href="#">Table 4</a>	24	192.3
			30	153.8
			36	128.2
			42	109.9
			48	96.1
			54	77.2
			60	62.6
			66	51.7
36" wide PBR (26 ga. steel)	Min 2.5-inch wide support <sup>3</sup>	See <a href="#">Table 4</a>	24	191.4
			30	153.1
			36	127.6
			42	109.4
			48	86.4
			54	68.3
			60	55.3
			36" wide PBR (24 ga. steel)	Min 2.5-inch wide support <sup>3</sup>
30	245.1			
36	204.2			
42	153.3			
48	117.3			
54	92.7			
60	75.1			
66	62.1			
36" wide PBR (24 ga. steel)	Min 2.5-inch wide support <sup>3</sup>	See <a href="#">Table 4</a>	72	52.2
			72	52.2

**TABLE 5- ALLOWABLE UNIFORM GRAVITY LOADS FOR METAL ROOF PANELS INSTALLED ON SPACED SUPPORTS<sup>1,2</sup>**  
(continued)

TAYLOR METAL ROOF PANEL	SUPPORT	FASTENING PATTERN	MAXIMUM SUPPORT SPACING (inches)	ALLOWABLE UNIFORM LOAD (psf)
34" wide HR-34 (0.032" aluminum)	Min 2.5-inch wide support <sup>3</sup>	See <a href="#">Table 4</a>	24	63.2
			30	50.6
			36	42.1
34" wide HR-34 (0.032" aluminum)	Min 2.5-inch wide support <sup>3</sup>	See <a href="#">Table 4</a>	24	98.6
			30	78.9
			36	65.8
			42	56.4
34" wide HR-34 (26 ga. steel)	Min 2.5-inch wide support <sup>3</sup>	See <a href="#">Table 4</a>	48	49.3
			24	234.6
			30	187.6
			36	156.4
			42	134.0
			48	117.3
34" wide HR-34 (24 ga. steel)	Min 2.5-inch wide support <sup>3</sup>	See <a href="#">Table 4</a>	54	104.2
			60	93.8
			66	85.3
			72	85.3
			24	318.2
			30	254.6
			36	212.1
			42	181.8
			48	159.1
			54	141.4
34" wide HR-34 (22 ga. steel)	Min 2.5-inch wide support <sup>3</sup>	See <a href="#">Table 4</a>	60	123.3
			66	101.9
			72	85.6
			96	48.2
			24	361.8
			30	289.5
			36	241.2
			42	206.8
34" wide HR-34 (20 ga. steel)	Min 2.5-inch wide support <sup>3</sup>	See <a href="#">Table 4</a>	48	180.9
			54	152.2
			60	127.3
			66	115.7
			72	106.1
			96	60.1
			24	380.0
			30	304.0
			36	253.3
			42	217.1
37.33" wide Classic 7/8 Corrugated (0.032" aluminum)	Min 2.5-inch wide support <sup>3</sup>	See <a href="#">Table 4</a>	48	190.0
			54	168.9
			60	142.7
			66	117.9
			72	99.1
			96	55.7
37.33" wide Classic 7/8 Corrugated (26 ga. steel)	Min 2.5-inch wide support <sup>3</sup>	See <a href="#">Table 4</a>	24	244.6
			30	156.6
			36	108.7
			42	79.9
			48	61.2
37.33" wide Classic 7/8 Corrugated (24 ga. steel)	Min 2.5-inch wide support <sup>3</sup>	See <a href="#">Table 4</a>	52	48.3
			24	356.3
			30	228.0
			36	158.3
			42	116.3
			48	89.1
			52	70.4
37.33" wide Classic 7/8 Corrugated (24 ga. steel)	Min 2.5-inch wide support <sup>3</sup>	See <a href="#">Table 4</a>	60	57.0
			24	485.6
			30	310.8
			36	215.8
			42	158.6
			48	121.4
			52	95.9
			60	77.7
66	64.2			
72	54.0			



**TABLE 5- ALLOWABLE UNIFORM GRAVITY LOADS FOR METAL ROOF PANELS INSTALLED ON SPACED SUPPORTS<sup>1,2</sup>**  
(continued)

TAYLOR METAL ROOF PANEL	SUPPORT	FASTENING PATTERN	MAXIMUM SUPPORT SPACING (inches)	ALLOWABLE UNIFORM LOAD (psf)
37.33" wide Classic 7/8 Corrugated (24 ga. steel)	Min 2.5-inch wide support <sup>3</sup>	See <a href="#">Table 4</a>	24	571.3
			30	365.6
			36	253.9
			42	186.5
			48	142.8
			52	112.8
			60	91.4
			66	75.5
36" wide BR-36 (0.032" aluminum) <sup>2</sup>	Min 2.5-inch wide support <sup>3</sup>	See <a href="#">Table 4</a>	72	63.5
			24	106.7
			30	68.3
			36	47.4
36" wide BR-36 (0.040" aluminum) <sup>2</sup>	Min 2.5-inch wide support <sup>3</sup>	See <a href="#">Table 4</a>	24	128.2
			30	102.6
			36	73.8
			42	54.2
36" wide BR-36 (24 gage steel) <sup>2</sup>	Min 2.5-inch wide support <sup>3</sup>	See <a href="#">Table 4</a>	24	490
			30	392
			36	280.6
			42	206.1
			48	157.8
			54	124.7
			60	101.0
			66	83.5
36" wide BR-36 (22 gage steel) <sup>2</sup>	Min 2.5-inch wide support <sup>3</sup>	See <a href="#">Table 4</a>	72	70.1
			24	676.8
			30	520.0
			36	361.1
			42	265.3
			48	203.1
			54	160.5
			60	130.0
			66	107.4
			72	90.3
36" wide BR-36 (20 gage steel) <sup>2</sup>	Min 2.5-inch wide support <sup>3</sup>	See <a href="#">Table 4</a>	96	50.8
			24	656.0
			30	514.8
			36	357.5
			42	262.7
			48	201.1
			54	158.9
			60	128.7
			66	106.4
			72	89.4
			96	50.3

For SI: 1 inch = 25.4 mm, 1 psf = 0.0479 kPa.

<sup>1</sup>Tabulated load values are based on panels uniformly loaded and installed on three or more equal span conditions.

<sup>2</sup>The tabulated spans are able to resist the concentrated roof live load of 300 lbf (1.33 kN) indicated in IBC Table 1607.1.

<sup>3</sup>The structural support must be designed to resist the applicable forces. When panels are installed over solid or closely fitted deck sheathing, the capacity is limited to the capacity of the underlying sheathing.

**TABLE 6-FIRE CLASSIFICATION ASSEMBLIES**

ROOF CLASSIFICATION	SUBSTRATE	MAX. ROOF SLOPE	ASSEMBLY DETAILS	
A	Noncombustible	Unlimited	Panels:	Versa Span, MS150, MS200, PBR, HR-34, Classic Corrugated 7/8 and BR-36 steel roof panels
			Insulation:	Any UL Classified roofing insulation, except for foam plastic insulation, minimum 1-inch-thick
A	Noncombustible	Unlimited	Panels:	Versa Span, MS150, MS200, PBR, HR-34, Classic Corrugated 7/8 and BR-36 steel roof panels
			Barrier Board:	Min. 15/32-inch-thick plywood
			Ply Sheet (optional):	Min. one ply ASTM D226 Type I (No. 115) or Type II (No. 30) asphalt saturated felt or UL Certified Type G1 mechanically fastened

TABLE 6-FIRE CLASSIFICATION ASSEMBLIES (continued)

ROOF CLASSIFICATION	SUBSTRATE	MAX. ROOF SLOPE	ASSEMBLY DETAILS	
A	Combustible	Unlimited	Panels:	Versa Span, MS150, MS200, PBR, HR-34, Classic Corrugated 7/8 and BR-36 steel roof panels
			Barrier Board:	Georgia Pacific ¼ inch minimum DensDeck board or ¼ inch minimum United States Gypsum Co SECUROCK Glass-Mat Roof Board (Type SGMRX), National Gypsum DEXcell Glass Mat Roof Board or DEXcell FV Glass Mat Roof Board, CertainTeed Gypsum GlasRoc or ½ inch minimum UL Certified gypsum board with all joints staggered a minimum of 6 inches from the plywood joints
			Ply Sheet (optional):	Min. one ply ASTM D226 Type I (No. 115) or Type II (No. 30) asphalt saturated felt or any UL Certified Type G1, G2 or G3 base or ply sheet mechanically fastened
A	Noncombustible	Unlimited	Panels:	Versa Span, MS150, MS200, PBR, HR-34, Classic Corrugated 7/8 and BR-36 steel roof panels
			Insulation:	Min. 1-inch-thick Perlite (ASTM C728) or wood fiber (ASTM C208, Type II)
			Ply Sheet (optional):	Min. one ply ASTM D226 Type I (No. 115) or Type II (No. 30) asphalt saturated felt or any UL Certified Type G1, G2 or G3 base or ply sheet mechanically fastened
A	Noncombustible	Unlimited	Panels:	Versa Span, MS150, MS200, PBR, HR-34, Classic Corrugated 7/8 and BR-36 steel roof panels
			Barrier Board:	Georgia Pacific ¼ inch minimum DensDeck board or ¼ inch minimum United States Gypsum Co SECUROCK Glass-Mat Roof Board (Type SGMRX), National Gypsum DEXcell Glass Mat Roof Board or DEXcell FV Glass Mat Roof Board, CertainTeed Gypsum GlasRoc or ½ inch minimum UL Certified gypsum board with all joints staggered a minimum of 6 inches from the plywood joints
			Ply Sheet (optional):	Min. one ply ASTM D226 Type I (No. 115) or Type II (No. 30) asphalt saturated felt or any UL Certified Type G1, G2 or G3 base or ply sheet mechanically fastened
A	Combustible	Unlimited	Panels:	Versa Span, MS150, MS200, PBR, HR-34, Classic Corrugated 7/8 and BR-36 steel roof panels
			Underlayment:	One layer Versashield Fire-resistant Roof Deck Protection mechanically fastened per ESR-2053 -or- One layer Polystick XFR self-adhered installed per ESR-1697
			Ply Sheet (optional):	Min. one ply ASTM D226 Type I (No. 15) or Type II (No. 30) asphalt saturated felt or any UL Certified Type G1, G2 or G3 base or ply sheet mechanically fastened
A (reroofing)	Combustible	Unlimited	Panels:	Versa Span, MS150, MS200, PBR, HR-34, Classic Corrugated 7/8 and BR-36 steel roof panels
			Existing Roof System:	Any Class A UL listed asphalt shingle
			Slip sheet:	One layer Versashield Fire-resistant Roof Deck Protection mechanically fastened per ESR-2053 -or- One layer Polystick XFR self-adhered installed per ESR-1697
A	Noncombustible	Unlimited	Panels:	Versa Span, MS150, MS200, PBR, HR-34, Classic Corrugated 7/8 and BR-36 aluminum roof panels

TABLE 6-FIRE CLASSIFICATION ASSEMBLIES (continued)

ROOF CLASSIFICATION	SUBSTRATE	MAX. ROOF SLOPE	ASSEMBLY DETAILS	
A	Combustible	Unlimited	Panels:	Versa Span, MS150, MS200, PBR, HR-34, Classic Corrugated 7/8 and BR-36 aluminum roof panels
			Underlayment:	Two layers Versashield Fire-resistant Roof Deck Protection mechanically fastened per ESR-2053-or- One layer Polystick XFR self-adhered installed per ESR-1697
B	Combustible	Unlimited	Panels:	Versa Span, MS150, MS200, PBR, HR-34, Classic Corrugated 7/8 and BR-36 aluminum roof panels
			Underlayment:	One layer Versashield Fire-resistant Roof Deck Protection mechanically fastened per ESR-2053

<sup>1</sup>Wood deck must be minimum 15/32-inch-thick plywood or non-veneer APA-rated 7/16-inch-thick oriented-strand board (OSB) or spaced sheathing. Steel deck must be a minimum of No. 22 gauge galvanized steel.

<sup>2</sup>GAF's VersaShield® Fire-Resistant Roof Deck Protection is evaluated under ICC-ES evaluation report ESR-2053 and must be installed in accordance with that report.

<sup>3</sup>Polyglass USA Polystick XFR self-adhered underlayment is evaluated under ICC-ES evaluation report ESR-1697 and must be installed in accordance with that report.



PANEL PROFILES

12", 14", 16", 18" coverage options



FLAT PAN



STRIATIONS

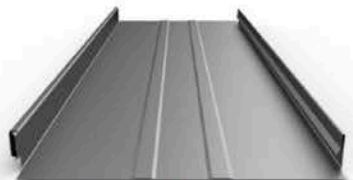

ACCENT RIBS 2 Accent ribs for 12" & 14" panel



ACCENT RIBS 3 Accent ribs for 16" & 18" panel



PENCIL RIBS

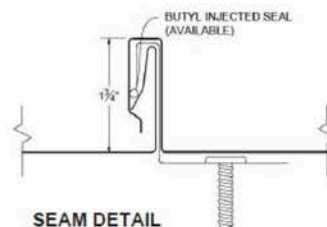

FIGURE 1- TAYLOR METAL PRODUCTS METAL ROOF PANELS



**TAYLOR METAL PRODUCTS** **MS-150™ MECHANICALLY SEAMED**

**PANEL PROFILES**

12", 16", and 18" coverage options

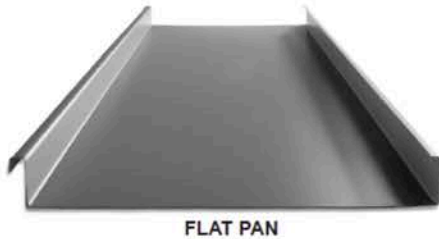
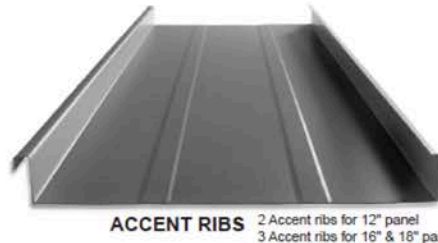
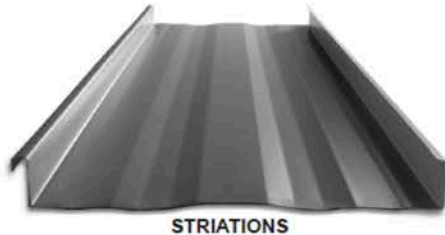

**90° SEAM DETAIL**

**180° SEAM DETAIL**

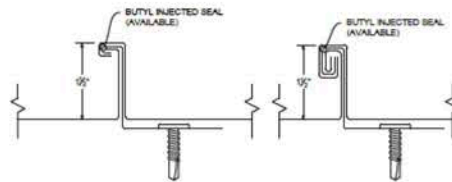

**TAYLOR METAL PRODUCTS** **MS-200™ MECHANICALLY SEAMED**

**PANEL PROFILES**

12", 14", 16", and 18" coverage options

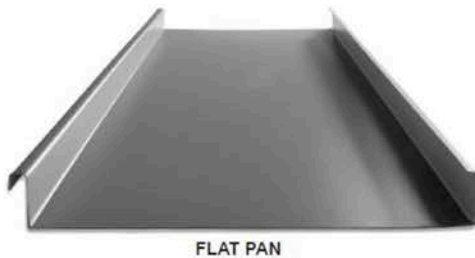
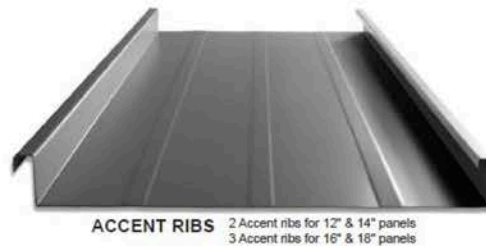
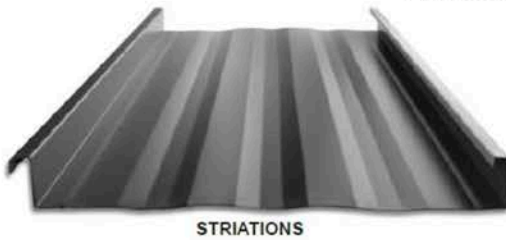

**90° SEAM DETAIL**

**180° SEAM DETAIL**

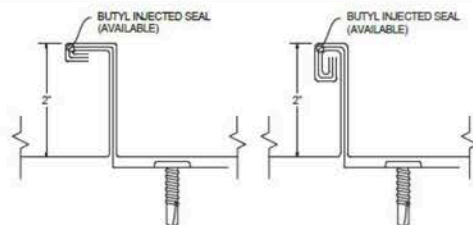

**FIGURE 1- TAYLOR METAL PRODUCTS METAL ROOF PANELS (continued)**

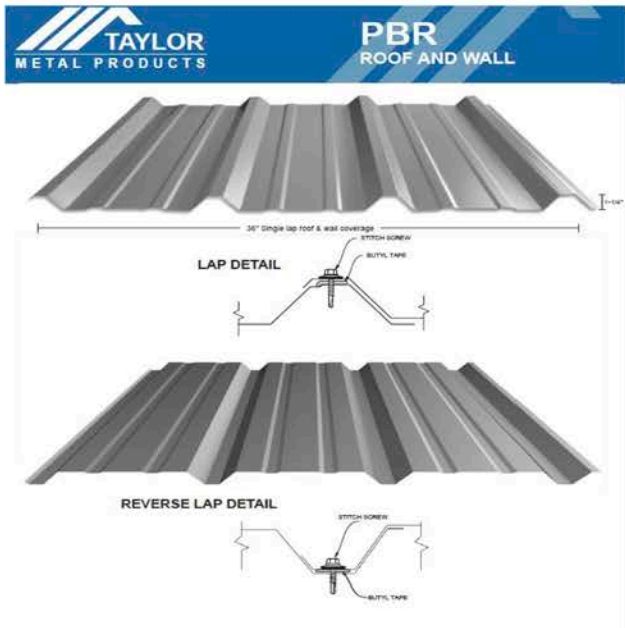

**ROOFING/SIDING PANEL APPLICATION**

3 FASTENERS



6 FASTENERS- HIGH WIND



**REVERSED SIDING PANEL APPLICATION**



**ROOF PANEL APPLICATION**

5 FASTENERS



7 FASTENERS- HIGH WIND



**SIDING PANEL APPLICATION**



**FIGURE 1- TAYLOR METAL PRODUCTS METAL ROOF PANELS (continued)**

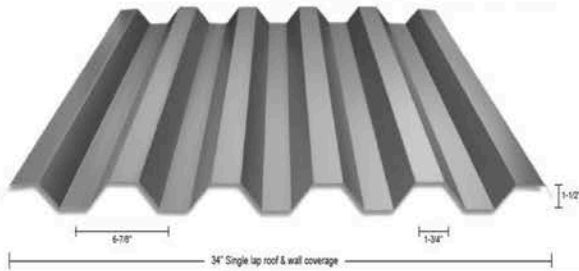

**LAP DETAIL**

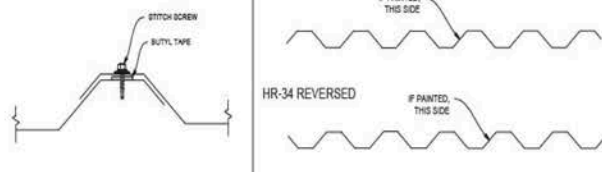

**ROOFING/SIDING PANEL APPLICATION**

3 FASTENERS

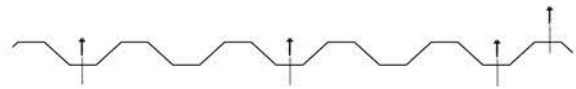

5 FASTENERS- HIGH WIND

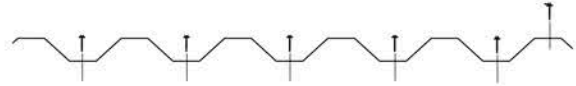

**REVERSED SIDING PANEL APPLICATION**

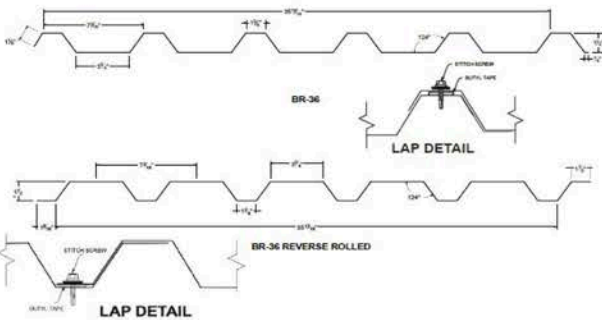
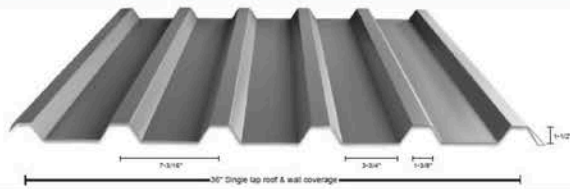
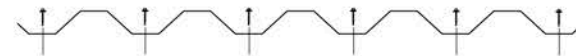

**ROOFING/SIDING PANEL APPLICATION**

3 FASTENERS



5 FASTENERS- HIGH WIND

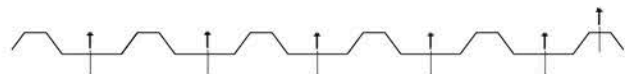

**REVERSED SIDING PANEL APPLICATION**



FIGURE 1- TAYLOR METAL PRODUCTS METAL ROOF PANELS (continued)



# 1-3/4" Versa-Span Snap Lock Panel Clip

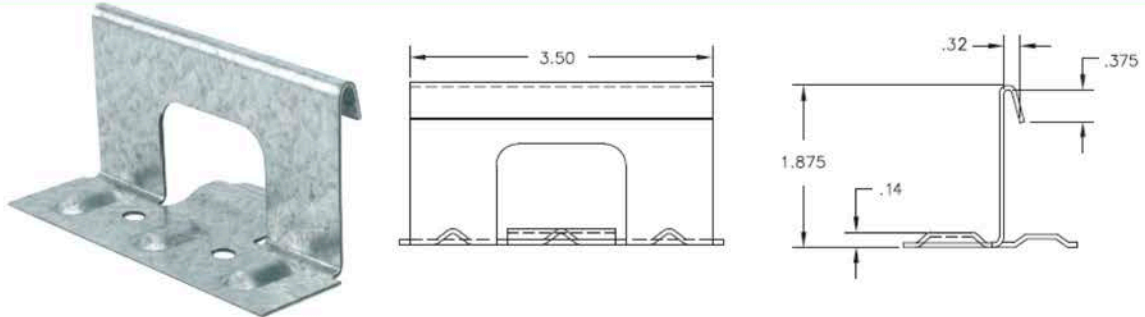

Item	Description
1-3/4" Snap lock clip	18 ga. (1.2 mm) G-90 Galvanized

Manufactured by:  
 Clip Master  
 SFS  
 AMSI

# 1-1/2" MS-150 Floating Clips

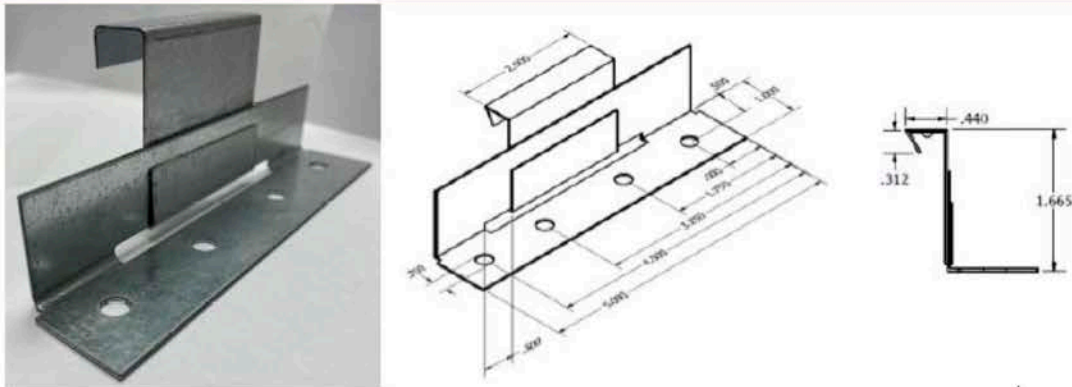

	Item	Base Material	Tab Material
* Sealant applied.	1-1/2" Float clip	18 ga. (1.5 mm) G-90 Galvanized	22 ga. (0.8 mm) G-90 Galvanized

Manufactured by:  
 Clip Master  
 AMSI

FIGURE 2- TAYLOR METAL PRODUCTS PANEL CLIPS FOR STANDING SEAM METAL ROOF PANELS

# 1-1/2" MS-150 Fixed Clip

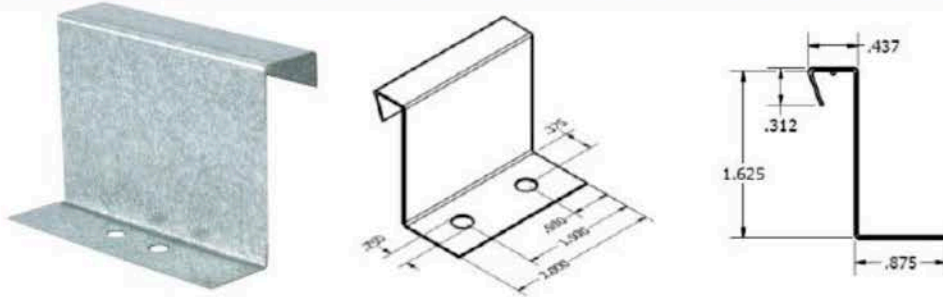

Material No.	Item	Description
* Sealant applied.	2" Fixed clip	22 ga. (0.8 mm) G-90 Galvanized

Manufactured by:  
Clip Master  
SFS  
AMSI

# 2" MS-200 Floating Clip

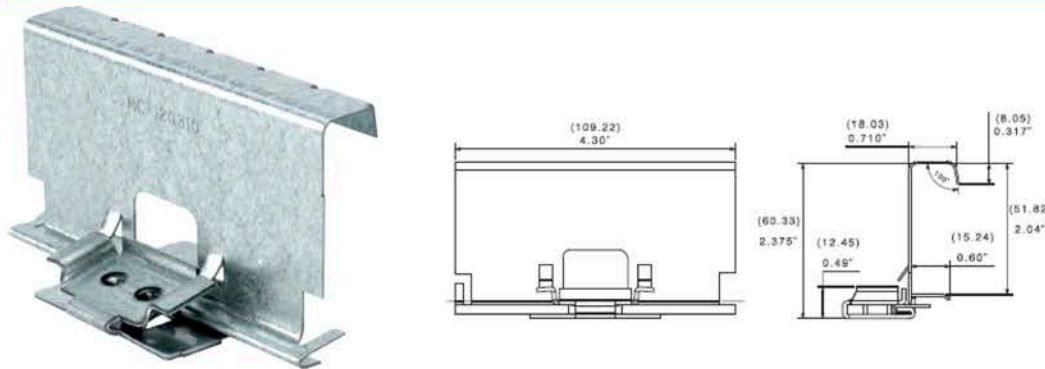

Material No.	Item	Base Material	Tab Material
1184718*	2" Float clip	16 ga. (1.5 mm) G-90 Galvanized	22 ga. (0.8 mm) G-90 Galvanized

\* Sealant applied.

Manufactured by:  
SFS

FIGURE 2- TAYLOR METAL PRODUCTS PANEL CLIPS FOR STANDING SEAM METAL ROOF PANELS (continued)

# 2" MS-200 Fixed Clip

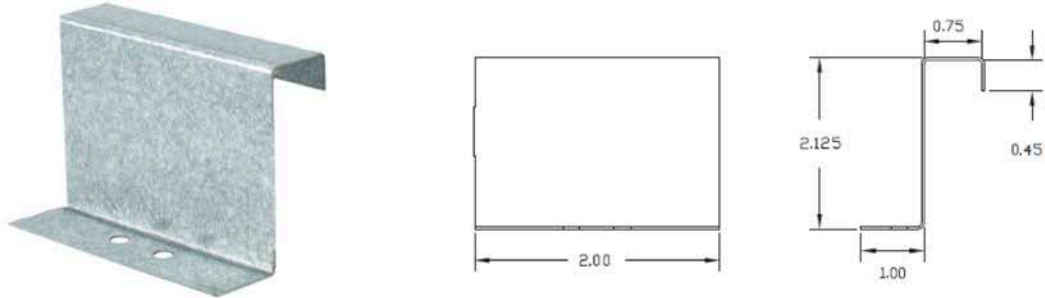

Material No.	Item	Description
*Sealant applied.	2" Fixed clip	22 ga. (0.8 mm) G-90 Galvanized

Manufactured by:  
 Clip Master  
 SFS  
 AMSI

FIGURE 2- TAYLOR METAL PRODUCTS PANEL CLIPS FOR STANDING SEAM METAL ROOF PANELS (continued)



**DIVISION: 07 00 00—THERMAL AND MOISTURE PROTECTION**  
**Section: 07 41 13—Metal Roof Panels**

**REPORT HOLDER:**

**TAYLOR METAL INC. (dba TAYLOR METAL PRODUCTS)**

**EVALUATION SUBJECT:**

**TMP METAL ROOFING PANELS**

**1.0 REPORT PURPOSE AND SCOPE****Purpose:**

The purpose of this evaluation report supplement is to indicate that the TMP metal roofing panels, described in ICC-ES evaluation report [ESR-5046](#), have also been evaluated for compliance with the codes noted below as adopted by the Los Angeles Department of Building and Safety (LADBS).

**Applicable code editions:**

- 2020 *City of Los Angeles Building Code* (LABC)
- 2020 *City of Los Angeles Residential Code* (LARC)

**2.0 CONCLUSIONS**

The TMP metal roofing panels, described in Sections 2.0 through 7.0 of the evaluation report [ESR-5046](#), comply with the LABC Chapter 15, and the LARC Chapter 9, and are subject to the conditions of use described in this supplement.

**3.0 CONDITIONS OF USE**

The TMP metal roofing panels described in this evaluation report supplement must comply with all of the following conditions:

- All applicable sections in the evaluation report [ESR-5046](#).
- The design, installation, conditions of use and identification of the TMP metal roofing panels are in accordance with the 2018 *International Building Code*® (IBC) provisions noted in the evaluation report [ESR-5046](#).
- The design, installation and inspection are in accordance with additional requirements of LABC Chapters 16 and 17, as applicable.
- The TMP metal roofing panels must not be installed over existing wood shakes or wood shingles in accordance with LABC Section 1511.
- The installation of the TMP Metal roofing panels must comply with City of Los Angeles Information Bulletin P/BC 2020-16, "Dwellings in High Wind Velocity Areas (HWA)".

This supplement expires concurrently with the evaluation report, reissued November 2023.

**DIVISION: 07 00 00—THERMAL AND MOISTURE PROTECTION**  
**Section: 07 41 13—Metal Roof Panels**

**REPORT HOLDER:**

**TAYLOR METAL INC. (dba TAYLOR METAL PRODUCTS)**

**EVALUATION SUBJECT:**

**TMP METAL ROOFING PANELS**

**1.0 REPORT PURPOSE AND SCOPE****Purpose:**

The purpose of this evaluation report supplement is to indicate that the TMP metal roofing panels, described in ICC-ES evaluation report ESR-5046, have also been evaluated for compliance with the codes noted below.

**Applicable code editions:**

- 2022 and 2019 California Building Code (CBC)

For evaluation of applicable chapters adopted by the California Office of Statewide Health Planning and Development (OSHPD) AKA: California Department of Health Care Access and Information (HCAI) and the Division of State Architect (DSA), see Sections 2.1.1 and 2.1.2 below.

- 2022 and 2019 California Residential Code (CRC)

**2.0 CONCLUSIONS****2.1 CBC:**

The TMP metal roofing panels, described in Sections 2.0 through 7.0 of the evaluation report ESR-5046, may be used where the CBC requires a Class A roof covering complying with 2022 or 2019 CBC Section 1505.1.1, a Class B roof covering complying with 2019 CBC Section 1505.1.2, or a Class C roof covering complying with 2022 CBC Section 1505.1.2 or 2019 CBC Section 1505.1.3, provided the design and installation are in accordance with the 2021 and 2018 *International Building Code*® (IBC) provisions noted in the evaluation report, and the additional requirements of CBC Chapters 16 and 17 as applicable.

**2.1.1 OSHPD:** The TMP metal roofing panels, described in Sections 2.0 through 7.0 of the evaluation report ESR-5046, comply with CBC Chapter 15 with applicable amendments [OSHPD 1, 1R, 2, 3, 4 and 5], provided the design and installation are in accordance with the 2021 and 2018 *International Building Code*® (IBC) provisions noted in the evaluation report and the additional requirements in CBC Chapters 16, 16A, 17 and 17A, as applicable.

**2.1.2 DSA:** The TMP metal roofing panels, described in Sections 2.0 through 7.0 of the evaluation report ESR-5046, comply with CBC Chapter 15 with applicable amendments [DSA-SS, DSA-SS/CC], provided the design and installation are in accordance with the 2021 and 2018 *International Building Code*® (IBC) provisions noted in the evaluation report and the additional requirements in CBC Chapters 16, 16A and 17A, as applicable.

**2.2 CRC:**

The TMP metal roofing panels, described in Sections 2.0 through 7.0 of the evaluation report ESR-5046, may be used where the CRC requires a Class A roof covering complying with 2022 or 2019 CRC Section R902.1.1, a Class B roof covering complying with 2019 CRC Section R902.1.2, or a Class C roof covering complying with 2022 CRC Section R902.1.2 or 2019 CRC Section R902.1.3, provided the design and installation are in accordance with the 2021 and 2018 *International Residential Code*® (IRC) provisions noted in the evaluation report and the additional requirements of CRC Section R905.4.

This supplement expires concurrently with the evaluation report, reissued November 2023.